

TICKETTOTHETHEMOON



Contact us for
co-branding or
personalization
requirements!

Headquarter Bali:
+62 361 419 288 office@tickettothemoon.com
tickettothemoon.com

Ticket to the Moon Europe:
+43 660 637 8417
office.europe@tickettothemoon.com
eu.tickettothemoon.com



Re:connect



WORKBOOK

2027

2027 — LET'S RECONNECT WITH OUR WILD NATURE!



The world is moving faster than ever. In this era of rapid change and information overload, the challenge of finding true rest and balance is real and should be addressed. We are collectively moving away from the relentless pursuit of performance and towards a deep need for regeneration. This movement is driven by a shared, vital desire for connection — with nature, with people, and with ourselves. This profound cultural shift is why we have chosen the motto for this workbook: "Re:connect." We see people moving from impulsive consumerism to intentional ritual, seeking products that carry genuine meaning. The market's "eco-hype" is giving way to a grounded movement we think of as "Sustainable Simplicity" — sustainability

practiced with humility, not moral pressure. Above all, authenticity beats perfection as we seek real materials, real places, and real connections to anchor us. Your journey to reconnect with your wild nature, your inner self, and your inner child is a timely and powerful one. This is where Ticket To The Moon (TTM) steps in. Our mission is to be your steadfast companion on this path, making the seemingly hard things less heavy and the beautiful moments even more light-headed.

2027 — LET'S RECONNECT WITH OUR WILD NATURE!



We fulfill this mission by ensuring every product is a ticket to a moment of peace. We are committed to using human-friendly materials and connecting people to people through fair values and craftsmanship. Our dedication to the planet is a continuous journey, reflected in our ambitious goals: Aiming for a total share of 60% recycled fabrics and 100% recycled aluminum in our products, all while continuously reviewing and improving our CO2 footprint by initiatives like the extension of our photovoltaics system to currently 80% of the total capacity and the start to our electric fleet for deliveries in our home in Bali.

We will keep creating products designed to aid your personal quest for balance and self-determination. This workbook is a gentle invitation to pause, look inward, and embrace this year full of transformative opportunities.

Stay wild, moon child!

WHATS NEW 2027

Our product range of life and travel companions just keeps growing- more colorful than ever before. Our 30th year in action proved to be one of the most successful ones so far. Our highlights include opening a 600 m2 store in Bali, processing

and learning tremendously from the ISO 9001 certification, hiring numerous young professionals to support our tribe, expanding our foundation projects and last but not least being able to share our happiness with you via these newcomers:



Hey kids and free spirits, listen up! Hammocking just got way more fun and accessible. With two new hammock sets in different sizes that shine in the colors of a rainbow we are ready for fun and adventures ahead!



Say hello to our new all-in-one insulated sleeping system that boasts all your favourite PRO hammock features!



Our 30kg accessory carabiners were reengineered and can now carry an incredible 100kg!!! Another highlight!



We are very excited about the slingbag range newcomers- 1 for "mini-me"s or minimalists, the other one for those appreciating extra space!



To all the mindfulness lovers: may you experience bliss with our new Yoga hammock, as well as when travelling with your yoga essentials in our Bali heritage-style bags.



Small but mighty! This foldable back cover might surprise you with its many uses, e.g. as a pop-up sitting mat when sitting on the wet ground alone or with a friend



We love that we want to share with you- for your keys inside your Slingbag, attaching gear when exploring, and all kinds of stuff that you want safe and always nearby.

CONTENT LIST

TTTTM IN A NUTSHELL **01**

TRAVEL LINE HAMMOCKS **10**

TECHNICAL LINE HAMMOCKS **21**

ATTACHMENT KITS **29**

ACCESSORIES **41**

RE.VIVED SERIES **49**

LIFESTYLE & YOGA PRODUCTS **65**

PREMIUM LINE **74**

POINT OF SALE **80**

COMMUNITY **82**

FAIR PRODUCTION



Our long-term goal is to raise awareness of larger global challenges and fair production issues. In all our operations, we aim to bring advancement to the community while respecting and supporting the local social structures. **ACT LOCAL!** Most of our partners and materials originate from Indonesia — our beloved nest and home. Ticket to the Moon is not only a brand but also a factory! We have **300+ team members** working across **5,000 m²** of **production space** and are proudly crafting all products on the island of Bali. All upcycled items include a **'Made By'** label to create a more personal link between customer and maker.

At Ticket to the Moon, we're committed to offering products that are not only **innovative** and **high-performing** but also gentle on the environment. Our fabrics are entirely **PFC-free** and certified according to the **OEKO-TEX® Standard 100**. This means they have been tested for harmful substances and are proven to be safe in human ecological terms. This commitment ensures our products are **skin-friendly** and **safe for everyone** — including children and those with sensitive skin.

Join us in **reducing our impact on the planet**. With a commitment to local sourcing, resource-efficient production, and **innovative upcycling** methods, we offer durable, high-quality products with genuine ecological value. Experience the benefits of local value creation and thoughtful packaging design. Every leftover material finds new life in our **re.vived series** or is recycled into fresh nylon chips. Explore our sustainable practices and make a difference today.

We are committed to maintaining the highest standards of **sustainability and environmental responsibility in our production**. A portion of the materials used in our products is bluesign® certified, ensuring they meet stringent criteria for resource efficiency, consumer safety, and minimal environmental impact. Additionally, our entire product line is **OEKO-TEX® Standard 100 certified**, guaranteeing that every component is tested for harmful substances and meets globally recognized safety standards. To further strengthen our commitment to responsible manufacturing, we are in the process of **obtaining ISO 9001 certification**. These will enhance our quality management systems and reinforce our dedication to sustainable business practices.

Since day one, we have defined ourselves not only as a manufacturer of feel-good products, but also as an advocate for socially responsible production conditions and **fair trade at all levels**. Together with the fair trade movement, we share the vision of more justice, transparency and sustainability in international trade (World Fair Trade Organization, 2009).



MEMBER



As a **recognized partner of the Austrian, South Tyrolean and German world shops**, we guarantee a number of criteria at every stage of the production process — including fair working conditions, fair trade practices, and environmental protection. We have been an **official WFTO member since 2023**. With honesty and mindfulness, we are heading full steam ahead towards our utopia — for our employees, for our suppliers and for our planet.

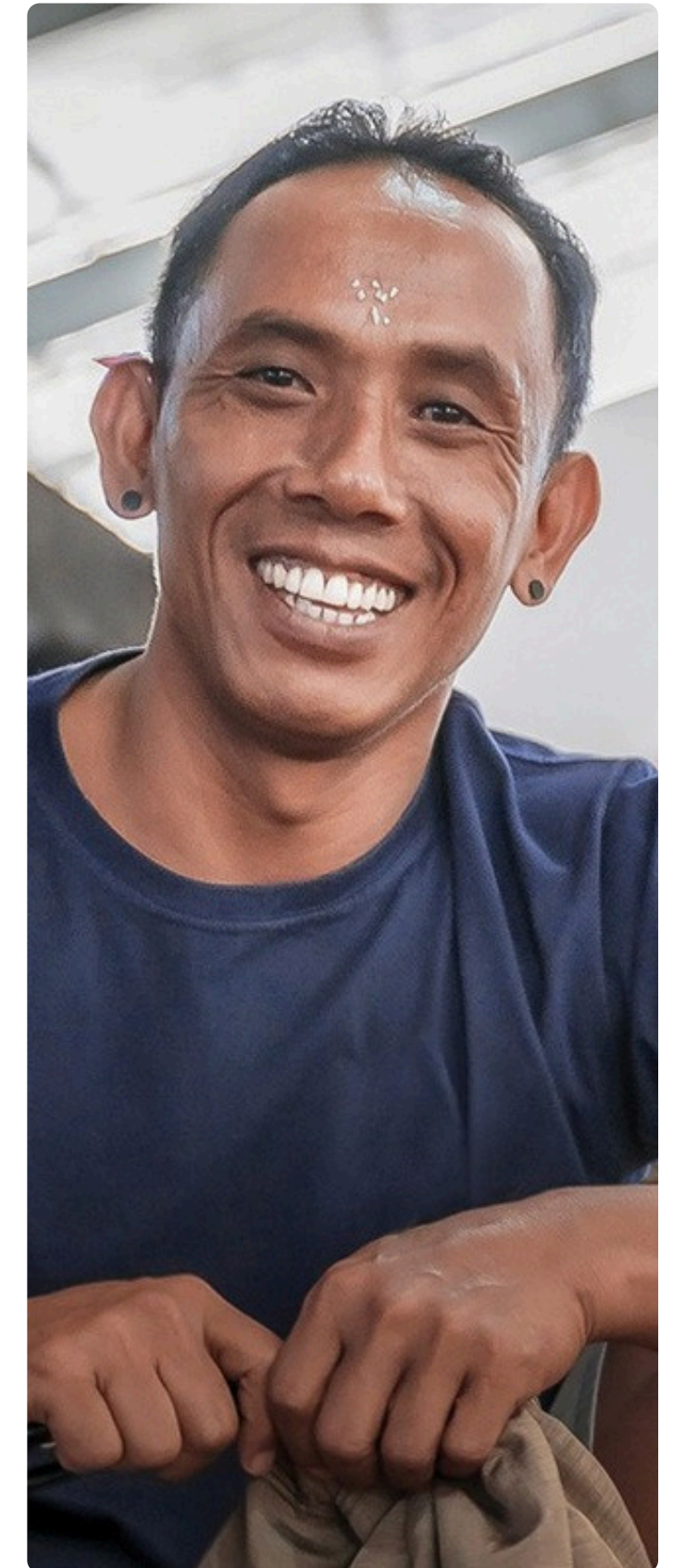

“We live and work in Bali, produced at our home”

HANDCRAFTED IN BALI WITH LOVE

CERTIFIED QUALITY MANAGEMENT

Ticket To The Moon (PT. Ayunan Bulan International) is proud to operate under an **ISO 9001:2015** certified Quality Management System, independently certified by **SGS**.

This certification reflects our commitment to consistent processes, continuous improvement, responsible production, and reliable quality — from product development and purchasing to production, quality control, and customer care.

For our customers and partners, it means that the way we work is regularly audited and verified against an internationally recognized quality management standard.



Quality is our third pillar (where it gets really detailed), alongside our **ethical practices** and **community approach**. To ensure the hammock flow, we start with the incoming materials. Upon arrival, samples of all security-relevant components are collected and taken to our testing room.

After the workstation inspections, every product is checked again before leaving the production.



TESTING MACHINE



Product Testing Machine

Before entering production, all components undergo testing with our **tensile testing machine**, where measurement sensors record key parameters and save a protocol in our QC database. For certain parts, like the S-hooks, we conduct continuous testing on every batch produced. We've also developed a **unique testing procedure for fabrics** to ensure their suitability for hammocks and consistent quality across every batch and color. The sewing of our straps is carefully monitored, and we **thoroughly inspect** final products to guarantee that you receive **perfectly crafted items** made with love in Bali.

TRAVEL LINE



COMPACT



ORIGINAL



KING SIZE



HONEY-
MOON SET



MINI SET



















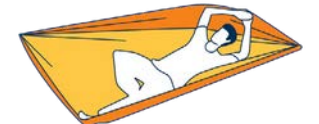









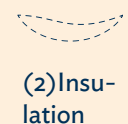









RAINBOW
SETS



MAMMOCK
SET

YOUR GUIDE TO THE PERFECT HAMMOCK

 All hammocks come with an Express Bag: quick, off-the-ground packing

			Specifications:	Accessories included:	Info:
 Travel & Everyday life	COMPACT		↔ 155 cm // 320 cm 📦 500 g 🏋️ 200 kg	 S-Hook	A favourite among beginners
	ORIGINAL		↔ 200 cm // 320 cm 📦 600 g 🏋️ 200 kg	 S-Hook	The Classic (1-2 people)
	KING SIZE		↔ 230 cm // 320 cm 📦 700 g 🏋️ 200 kg	 S-Hook	More Space
 Camping	PRO		↔ 170 cm // 325 cm 📦 880 g 🏋️ 150 kg	 6 kN  Mosquito Net  Ridgeline	The all-rounder
	(1) PRO MAT (2) THERMO		↔ 170 cm // 325 cm 📦 (1)920 g 📦 (2)1285 g 🏋️ 150 kg	 6 kN  Mosquito Net  Ridgeline  (2) Insulation	Insulated(2) sleeping system or option to add mat
	LIGHTEST PRO		↔ 140 cm // 310 cm 📦 590 g 🏋️ 100 g	 6 kN  Mosquito Net  Ridgeline	Ultra-light complete set
 Ultralight	LIGHTEST		↔ 140 cm // 320 cm 📦 220 g 🏋️ 150 kg	 6kN	lightweight, compact & always with you
 Home & Garden	HOME HAMMOCK 320, 420, 520		↔ 230 / 300 / 300 cm // 320 / 420 / 520 cm 📦 1.220 / 1.880 / 2.260 g 🏋️ 300 / 300 / 300 kg	 10 kN  Nautical ropes  Sleeve	Relaxation for the home
	HONEY-MOON		↔ 300 cm // 500 cm 📦 1.420 g 🏋️ 300 kg	 22 kN  Suspension ropes  Sleeve	1-4 people
	MAMMOCK		↔ 450 cm // 800 cm 📦 3.600 g 🏋️ 350 kg	 22 kN  Suspension ropes  Sleeve	Playground

COMPACT

(TMC)



Dark Green
(TMC05)



Royal Blue
(TMC39)



Plum
(TMC78)



Leaf Green
(TMC85)



Sand
(TMC70)



Petrol Green
(TMC89)

- Durable
- Great value
- Single piece of fabric
- Easy to use
- Entry-level hammock for young and smaller users

Included:



Express Bag



S-Hook

Material	Parachute nylon 70D 64 g/m ²
Weight	500 g
Length hook to hook	320 cm
Width	155 cm
Max. load	200 kg
Fabric length	300 cm
Breaking strength:	
Hook	>380 kg
Carabiner	>580 kg

ORIGINAL

(TMO)



Dark Green & Army Green
(TMO0524)



Aqua & Dark Grey
(TMO1503)



Army Green & Brown
(TMO2408)



Emerald Green & Green
(TMO3611)



Plum & Peach
(TMO7876)



Petrol Green & Dark Grey
(TMO8903)

- Best-selling every-day hammock
- Wide and colourful
- Amazing all-night sleep
- Featuring triple stitching
- Durable and reliable companion

Included:



Express Bag



S-Hook

Material	Parachute nylon 70D 64 g/m ²
Weight	600 g
Length hook to hook	320 cm
Width	200 cm
Max. load	200 kg
Fabric length	300 cm
Breaking strength:	
Hook	>380 kg
Carabiner	>580 kg

KING SIZE

(TMK)

MINI SET

(TMMINI)



Emerald Green & Green
(TMMINI3611)



Brown & Brown
(TMKo8o8)



Army Green & Brown
(TMK24o8)



Plum & Light Purple
(TMMINI7819)



Burgundy & Dark Yellow
(TMK3437)



Emerald Green & Green
(TMK3611)



Royal Blue & Turquoise
(TMK3914)



Dark Green & Leaf Green
(TMKo585)

- Extra-wide version of the Original Hammock
- Ideal for taller users and extra flat sleeping
- Comfort wonder
- Enough room for 2 adults

Material	Parachute Nylon 70D 64 g/m ²
Weight	700 g
Length hook to hook	320 cm
Width	230 cm
Max. load	200 kg
Fabric length	300 cm
Breaking strength:	
Hook	>380 kg
Carabiner	>580 kg

Included:



Express Bag



S-Hook

- Multi purpose set (hammock, carabiners, ropes)
- Gear hammock, keeping your belongings off the ground
- Hammock for kids
- Fits under adult size hammock

Included:



Express Bag



6kN Carabiners



Rope Set (2x)

Material	Parachute Nylon 70D 64 g/m ²
Weight	315 g
Length hook to hook	160 cm
Width	100 cm
Max. load	150 kg
Fabric length	140 cm
Breaking strength	>350 kg



HONEYMOON SET

(TMHM)



Dark Green & Jade Green
(TMHM0573)



Burgundy & Dark Yellow
(TMHM3437)

- Maximum comfort
- Easy to install
- Ideal for couples, families and larger folks

Included:

Express Bag 22kN Carabiners

Hammock Sleeve Moon Straps Plus

Material	Parachute Nylon 70D 64 g/m ²
Weight	1420 g
Length hook to hook	500 cm
Width	300 cm
Max. load	300 kg
Fabric length	480 cm
Breaking strength	>900 kg



MAMMOCK

(TMM)



WHAT A GIANT HAMMOCK!!!

- The largest commercially available hammock
- Designed for parties, fun, and unforgettable moments
- The center of attention in any garden, at any event, school, or gathering
- Roomy enough for several adults to relax together

Mini	Compact - Original - King Size	Honeymoon	Mammoth
Weight	3600 g		
Length hook to hook	800 cm		
Width	450 cm		
Max. load	350 kg		
Fabric length	780 cm		
Breaking strength	>980 kg		



Olive Brown & Sparkling Gold
(TMM4323)

Included:

Express Bag Hammock Sleeve 22kN Carabiners Moon Strap Plus

RAINBOW HAMMOCK SET

(TMKR)



Lightweight, compact, and ready for any adventure! This Kingsized hammock in an outstanding rainbow design is your reliable companion, whether you're hiking through the wilderness, travelling, or simply relaxing in the garden. This hammock with its colorful borders has been tested worldwide for decades and meets the highest standards of quality and functionality. Whether you're on an outdoor expedition or just taking a relaxing break.



- Most popular everyday hammock size
- Wide and colourful
- Amazing all-night sleep
- Featuring triple stitching
- Durable and reliable companion
- Lightweight & space-saving — fits in any backpack
- Extremely durable — tested under the toughest conditions
- Breathable & quick-drying material — for maximum comfort
- Set up in seconds — with the right hanging system
- Sustainably & fairly produced — made with love

Material	Parachute nylon 70D 64 g/m ²
Weight	940 g
Length hook to hook	320 cm
Width	230 cm
Max. load	200 kg
Fabric length	300 cm
Breaking strength: Hook	>380 kg
Carabiner	>580 kg



JUNIOR HAMMOCK SET

(TMJR)



Which hammock is the right size for little humans? After many requests for an interim size between the Mini and the Compact Hammock, we decided to develop a set. But we also wanted to make it fun. Our lovely production crew came back with this adorable design. We are completely amazed and are sure that your family and friends will love it too.

- Multi purpose set (hammock, carabiners, ropes)
- Gear hammock, keeping your belongings off the ground
- Hammock for kids
- Fits under adult size hammock

Material	Parachute Nylon 70D 64 g/m ²
Weight	500 g
Length hook to hook	210cm
Width	150 cm
Max. load	150 kg
Fabric length	200 cm
Breaking strength	>350 kg



TECHNICAL LINE



LIGHTEST HAMMOCK

(TMLR)



Forest Green (TMLR51)



Navy Blue (TMLR52)



Dark Grey (TMLR54)

- Ultra-light design
- High-grade recycled Nylon
- Packs tiny in Express Setting Bag
- Spliced UHMWPE ropes
- Recommended: Lightest Straps (not included)

Material	Recycled -Crinkle Nylon 20D 44g/m ²
Weight	220 g
Max. load	150 kg
Length	320 cm (carabiner to carabiner)
Fabric length	300 cm
Width	140 cm
Breaking strength	>450 kg

Included:



Express Bag



6kN Carabiners



When going far — or if every gram counts — even a conventional travel hammock might be too heavy. Some simply love the idea of having a hammock that can truly go anywhere, anytime, without having to leave anything else behind. After years of searching for an even lighter fabric that still offers the safety and comfort Ticket to the Moon is known for, we're excited to introduce our Lightest Hammock. It's an ultralight setup made from a locally produced, recycled high-performance crinkle nylon textile. This award-winning packing wonder features a full-length hammock body (300 cm) and is perfectly suited for taller users — without compromising on comfort. It weighs only 220 grams — including the express setting bag. Equipped with 6kN mini-carabiners and special UHMWPE-rope, it literally fits into your pocket.

LIGHTEST PRO HAMMOCK

(TMLPRORA)



Forest Green (TMLPROR51A)



Navy Blue (TMLPROR52A)



Dark Grey (TMLPROR54A)

- Ultra-lightweight adventurer's choice
- Insect protection with stowable mosquito net
- Tie-out elastic lines included to keep the bug-net away from the head and foot area
- Integrated ridgeline for extra comfort and smart storage organizer
- 4 zipper heads
- External loops to guide your Underquilt
- Quick and easy installation
- Recommended: Lightest Straps (not included)

Material	Recycled -Crinkle Nylon 20D 44 g/m ²
Weight	590 g
Max. load	100 kg
Length	325 cm (carabiner to carabiner)
Fabric length	310 cm
Width	140 cm
Breaking strength	>450 kg
Mosquito Net	200 holes/cm ²
Ridgeline	3 mm UHMWPE 2.8 m +-10 cm

Included:



Express Bag



Pair of 6kN Carabiners



Mosquito Net



Ridgeline Organizers

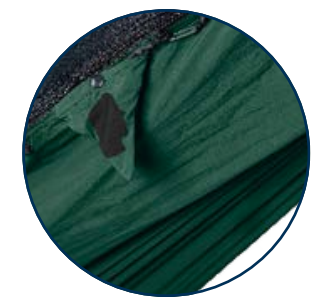

Elastic tie-out lines indicate head and foot position

PRO HAMMOCK

(TMPROA)



Brown
(TMPRO0807A)



Army Green
(TMPRO2407A)

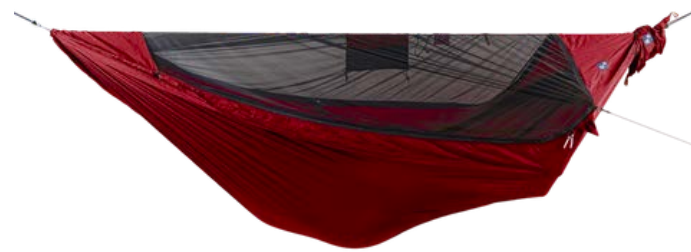

Burgundy
(TMPRO3407A)

- A versatile all-round outdoor hammock — made for comfort-loving adventurers
- Integrated and stowable mosquito net
- 2 Elastic tie-out lines keep bug net away from head and foot area
- Integrated ridgeline for extra comfort
- Organizer doubles as a (travel) light diffuser
- 4 zipper heads — easy bilateral access
- External loops to guide your Underquilt
- Quick and easy installation
- Recommended: Moon Straps (not included)

Material	Parachute Nylon 70D 64 g/m ²
Weight	860 g
Max. load	150 kg
Length	325 cm (carabiner to carabiner)
Fabric length	310 cm
Width	170 cm
Breaking strength	>450 kg
Mosquito Net	200 holes/cm ²
Ridgeline	3 mm UHMWPE 2.8 m +-10 cm

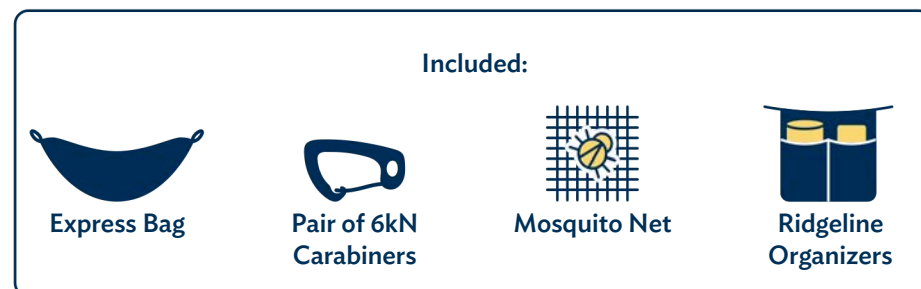

Ridgeline organizer

PRO MAT WIDE HAMMOCK

(TMPROMATA)



Navy Blue
TMPROMAT06A



Brown
(TMPROMAT08A)



Army Green
(TMPROMAT24A)

- All-round adventure hammock — fits all standard camping mattresses for insulation
- Integrated and stowable mosquito net
- 2 Elastic tie-out lines keep bug net away from head and foot area
- Integrated ridgeline for extra comfort
- Organizer doubles as a (travel) light diffuser
- 4 zipper heads — easy bilateral access
- External loops to guide your Underquilt
- Quick and easy installation
- Recommended: Moon Straps (not included)

Material	Parachute Nylon 70D 64 g/m ²
Mat compartment	Recycled -Crinkle Nylon 20D 44 g/m ²
Weight	920 g
Max. load	150 kg
Carabiner to carabiner	325 cm
Fabric length	310 cm
Width	170 cm
Breaking strength	>450 kg
Mosquito Net	200 holes/cm ²
Ridgeline	3 mm UHMWPE 2.8 m +-10 cm

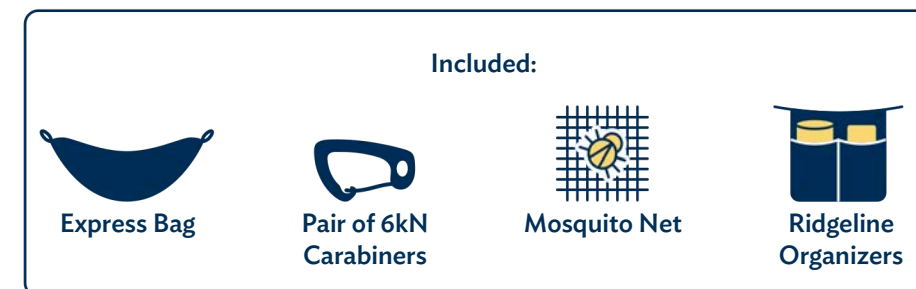
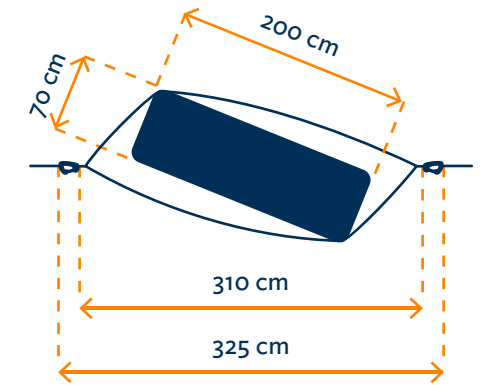

Elastic tie-out lines indicate head and foot position

THERMO PRO HAMMOCK

(TMTPRO)



Let us welcome the newest family member of the PRO hammock series!

It boasts a meticulously sewn-in bottom insulation that contours naturally to the body, providing consistent warmth and comfort! Apart from that, it is designed with the same unique functionality as the Pro Hammocks.

Just bring this compact hammock and your favourite straps, and you are ready to sleep warm wherever, without an additional quilt or camping mattress!



Brown -Grey
(TMTPRO08)



Army Green
(TMTPRO24)

- All-round insulated adventure hammock
- Integrated and stowable mosquito net
- 2 Elastic tie-out lines keep bug net away from head and foot area
- Integrated ridgeline for extra comfort
- Organizer doubles as a (travel) light diffuser
- 4 zipper heads — easy bilateral access
- External loops to guide your Underquilt
- Quick and easy installation
- Recommended: Moon Straps (not included)

Material	Parachute Nylon 70D 64 g/m ²				
Material mat compartment	Recycled -Crinkle Nylon 20D 44 g/m ²				
Weight	1285 g				
Max. load	150 kg				
Carabiner to carabiner	325 cm				
Fabric length	310 cm				
Width	170 cm				
Breaking strength	> 450 kg				
Mosquito Net	200 holes/cm ²				
Ridgeline	3 mm UHMWPE 2.8 m +-10 cm				
Temp Range	<table border="0"> <tr> <td>limit</td> <td>comfy</td> </tr> <tr> <td>0</td> <td>5 10 15 20 °C</td> </tr> </table>	limit	comfy	0	5 10 15 20 °C
limit	comfy				
0	5 10 15 20 °C				
Filling	115 g/m ² 100% RPET Insulation ECODOWN by Thermore®				

Included:



Express Bag



Pair of 6kN Carabiners



Mosquito Net



Ridgeline Organizers



Insulation

ATTACHMENT KITS

Connect & Hang (Nicer)



NAUTICAL ROPE KIT



Length	2.4 m
Diameter	Ø 5 mm
Weight	(preknotted)
Max. load	230 g
Material	100% Nylon
Breaking strength	>580 kg

An extremely durable, sturdy, and safe rope hanging system. This minimalist innovation — invented by Ticket to the Moon over 25 years ago — changed the hammock world forever. It allows anyone to hang a hammock within seconds, no knots needed. But if you want to, you can still add your own ;). (Two pieces per pouch!)

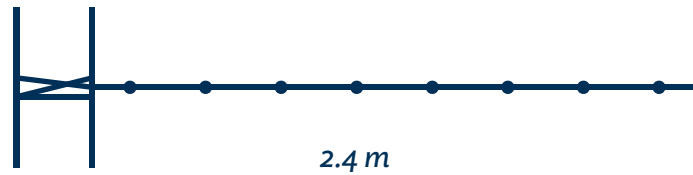

MOON STRAP



Length	2.7 m
Width	2 cm
Weight	216 g
Max. load	300 kg
Material	100% Polyester
Breaking strength	>760 kg

This daisy-chain webbing is ultra-strong, anti-slip, and incredibly easy to use. It's ideal for trees with sensitive bark or for hammocks shared by multiple people. (Two pieces per pouch!)



(TMROPE)

LIGHTEST STRAP



Full length	2.7 m
Tree-hugger	L: 1.2 m W: 2 cm
Rope	L: 1.5 m Ø 3 mm
Weight	95 g
Max. load	200 kg
Strap material	100% Polyester (PES)
Rope material	UHMWPE
Breaking strength	>400 kg

Weighing just 100 g, this tree-friendly and easy-to-use suspension system is perfect when every gram counts. Made from durable UHMWPE rope, it's built to last. It even fits into the express bag of our lightest hammock — and comes as a pair. (Two pieces per pouch!)



STRAP EXTENDER



Length	1.55 m
Width	2 cm
Weight	105 g
Max. load	300 kg
Material	100% Polyester
Breaking strength	>760 kg

Ever been just 10 cm short of reaching the perfect hammock hang? Sometimes trees are thicker or farther apart than expected — and that's where the Strap Extender comes in. This pair of durable polyester straps makes it easy to extend or upgrade your Lightest Straps, Moon Straps, or classic Ropes. (Two pieces per pouch!)



(TMTFSE)

STRAP EXTENDER PLUS

(TMTFSEP)



Full length 1.5 m
Weight 240 g
Max. load 350 kg
Strap material 100% Polyester
Breaking strength >900 kg

You want to be absolutely sure that the trees are only hugged and not hurt when installing your hammock? The Strap Extender Plus is optimised for permanent setups, for trees with sensitive bark, and for anyone who wants to give trees some extra care. They are compatible with all standard attachment systems. (Two pieces per pouch!)

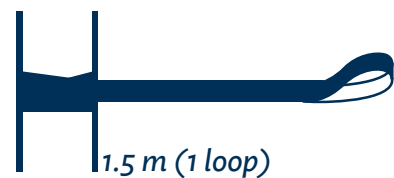

HANGING KIT

(TMWALL)



Back from your travels? Why not set up your hammock in the living room? It's the perfect spot to read a book, plan your next adventure, or simply unwind and relax. Suitable for use on concrete, brick, and wood surfaces.



Max. load 200 kg
Material Stainless Steel
Weight 155 g



- Set of 2 hangers
- Includes 2 screws, washers, and wall plugs
- Packaging designed for slat-wall display

2ND TREE KIT

(TM2NDTREE)



Dear bike-packers and cycling enthusiasts! This brand-new innovation might entirely change your next trip! All you need to get horizontal in your favorite travel hammock is a single tree or anchor point, your bike and the TTTM 2ND TREE.

In almost no time, the pegs are safely placed in the ground, serving as an anchor. They are then attached to the bike in a stable triangle shape that will keep your setup stable and safe. Enjoy the flexibility and get the most out of your adventures!

- 2x UHMWPE Whoopie Slings 2,3 m
- 3x 25 cm spiral Y-shaped pegs AL7075
- 3x 18 cm Y-shaped pegs aluminium
- 4x UHMWPE Loops 30 cm
- Max. Weight 160 g
- Min. Weight 98 g (2 pegs + 1 Whoopie Sling + loops)



2ND TREE can be used with a weak tree, your trekking poles, any wooden pole or even with a motorbike too!

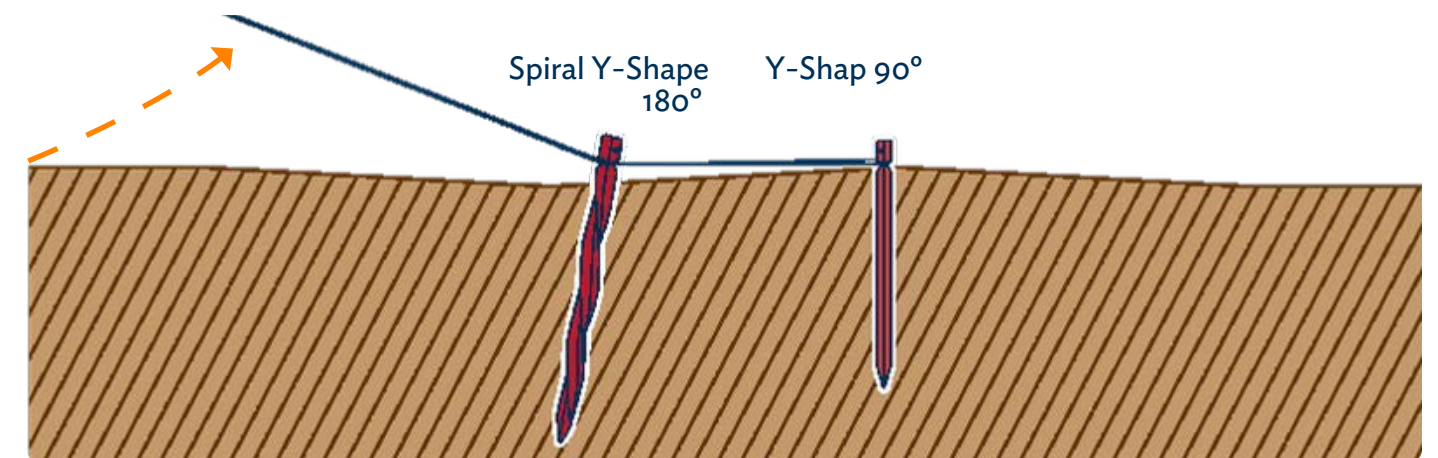

Make sure you do a proper set up position!



CARABINER 10 KN

(TMBINER10)



Size	6 × 3.9 cm
Material	A7075 T6
Weight	14.5 g/pc
Closed 	10kN
Opened 	3.5kN



If you like attaching gear to your hammock — or want extra safety for your joyfully playing children — consider upgrading to our weight-rated carabiners. Recently redesigned for even better security and reduced weight, they offer both peace of mind and added convenience when setting up your hammock.

Includes two pieces per pack!

CARABINER SET 6 KN

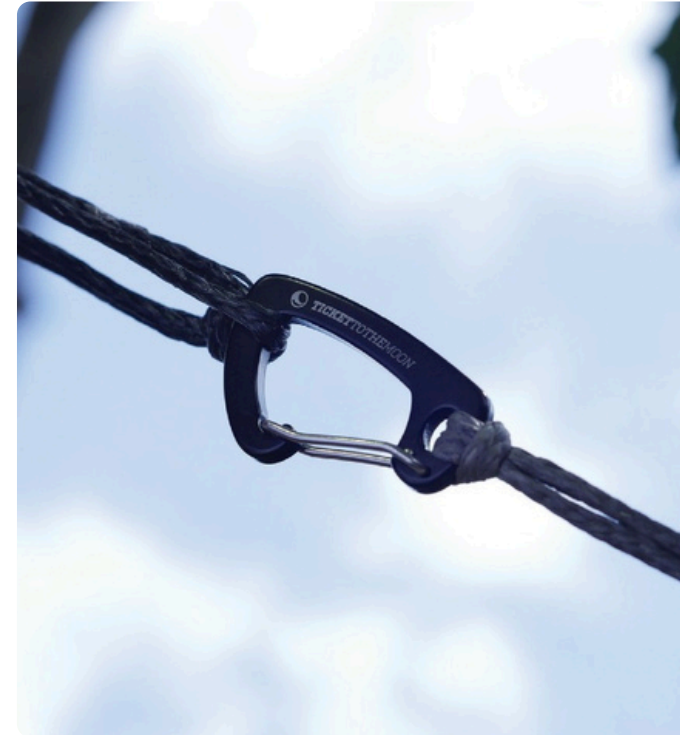
(TMBINER06)



Size	4.5 × 2.6 cm
Material	A7075 T6
Weight	6 g/pc
Closed 	6kN
Opened 	1.5kN



We designed this carabiner to be our most light-weight option — without compromising strength. With a closed gate rating of 600 kg, it's strong enough for any situation. The custom eyelet is perfectly suited for ropes like our UHMWPE lines. Ideal for the Lightest Hammock, it also doubles as a high-strength accessory carabiner.

Includes two pieces per pack!

CARABINER SET 22 KN

(TMBINER22)



Size	8.5 × 5.2 cm
Material	A7075 T6
Weight	34.4 g/pc
Closed 	22kN
Opened 	7kN

If you're looking for an extra level of safety, this carabiner is the perfect choice. Its added strength lets you easily open the gate — even while two dreamers are relaxing in the hammock.

Includes two pieces per pack!

ACCESSORY CARABINER SET

(TMBINER107)



Size	4 × 2.5 cm
Material	recycled A6061
Weight	3 g/pc
Closed 	100 kg

The perfect clips for securing smaller items like water bottles, knives, or flashlights to your Ticket to the Moon bag. These versatile carabiners also work great as key rings and can be used to manage guy lines and more.



One set contains 8 pieces.

UV SLEEVE

(TMHSUV)



Protects your hammock like a second skin from dirt, sun and wind. An essential, but optional accessory if you plan to leave it in UV light for an extended time. It keeps your hammock clean and stops the wind from flapping it around when not in use.

RIDGELINE SET BASIC

(TMRIDGEB)



Material	PU Coated 3 mm UHMWPE rope
Weight	70 g
Length	220 - 320 cm
Max. Load	200 kg
Breaking strength	450 kg

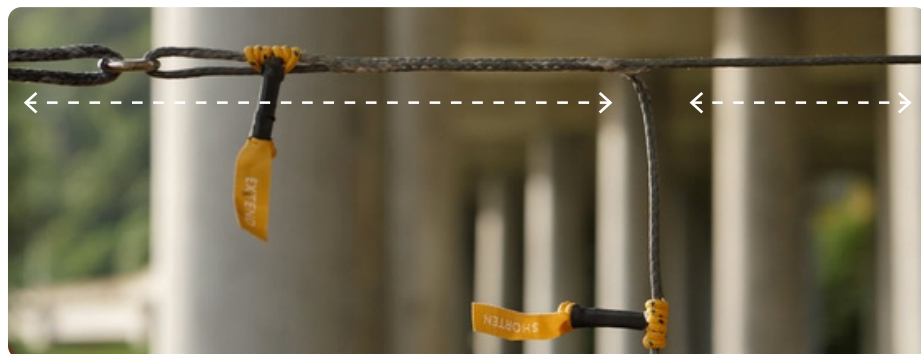

With this structural and adjustable ridgeline kit, you will certainly hang like a pro and find your perfect position-everywhere and always! Installation is super easy, and you will sleep much better! A clever fusion of state of the art materials and locked Brummel eye splice loop and whoopie sling technology make this accessory attractive for everyday use. It can be attached to the hammock using a girth hitch (like you attach the hook). The length is set by simply holding and pulling on the handles as indicated.

- UHMPE adjustable ridgeline 220 - 320 cm
- Organizer (6 compartments)
- Stainless-steel ring
- White mesh pocket (light diffuser)

PEGS SET

(TMPEG6Y)

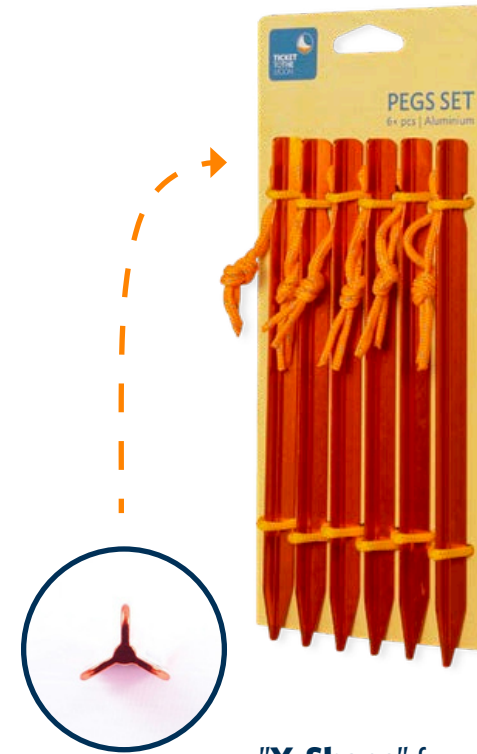

"Y-Shape" for extra strength!

Length	18 cm
Width	12 mm
Weight	12.8 g
Material	Aluminium

These lightweight Y-shaped pegs are designed to provide a secure hold in a wide range of outdoor conditions. Their special shape increases surface area for better grip in the ground and offers strong resistance against pulling out. Made from durable aluminium, they are built to handle everything from tarp and tent setups to more demanding backcountry use. At only 12.8 grams per peg, they keep your gear light while remaining reliable and versatile for a wide range of outdoor adventures.

- Y-shaped design
- Durable construction
- Lightweight and portable
- Multi-purpose use

WHOOPIE SLING

(TMWHOOPE)



Length	35 - 200 cm
Width	3 mm
Weight	55 g
Material	Ø 3 mm UHMWPE rope
Max. Load	200 kg
Breaking strength	500 kg

Upgrade your outdoor relaxation setup with the Whoopie Sling, the ultimate adjustable extension for effortless, secure hammock hanging. Engineered for versatility and strength, this lightweight rope system features a fully adjustable loop mechanism that lets you fine-tune tension and length without tying a single knot.

HAMMOCK ACCESSORIES

Stay Warm, Dry & Not Bitten

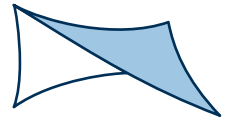

MOON TARP

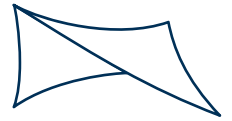

LIGHTEST
TARP



FULLMOON
TARP

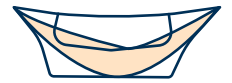

BUG NET
360°



MOONQUILT
ALLROUND



MOONQUILT
COMPACT



MOONQUIT
PRO 650



MOON
BLANKET
COMPACT



MOON
BLANKET
PRO 650



UV SLEEVE



MOON TARP

(TMTARPO5A)



Easily packable!

Material	PU — Coated recycled Ripstop Polyester
Min. Weight	(2000 mm water column)
Max. Weight	775 g (4× guy ropes)
Size	845 g (8× guy ropes, 2× pegs)
Diagonal	250 × 250 cm
Guy rope: Blue	350 cm
Yellow	2 × 2.5 m
Orange	4 × 2 m
	2 × 1 m (Incl. 8 carabiners & 8 quick-release-tension-buckles, 2 × pegs)

This diamond-shaped tarp can be used with standard hammocks or on its own as instant protection from the elements. Reinforced, seam-sealed ridgeline, corners and tie-out points make it highly durable and adaptable. Blue-colored ridgeline tie-outs with carabiners ensure easy orientation and quick setup. Four additional eyelets allow for various setup modes using extra cordage or poles. The adjustable guy lines are stored in convenient, breathable corner pockets for safekeeping.

- Waterproof (2000 mm)
- Fits all TTTM hammocks — except Honeymoon and Mammock
- Shields from rain, sun and wind
- Quick-release buckles for easy setup
- Compact and lightweight
- Comes in a Moon Pouch + with waterproof roll-top bag for safe transportation
- Contrast-colored ridgeline with carabiners for easy setup
- Mesh pockets for storing all guy lines

FULLMOON TARP

(TMFMTPARPA)



Material	P20D Recycled Ripstop Sil-Nylon
	1500 mm water column)
Min. Weight	585 g
Max. Weight	750 g (incl. 16× guy ropes, 6× pegs)
Size	320 × 280 cm
Diagonal	424 cm
Guy rope: Blue	2 × 2.5 m
Yellow	8 × 1.5 + 2 × 0.35 m
Orange	4 × 1 m (Incl. carabiners & quick-release-tension-buckles)



Easily packable in its roll top bag

The Fullmoon Tarp is an advanced all-weather shelter that can be set up in a variety of configurations. Whether as an A-frame, tent-like cover in challenging weather, or as a diamond tarp offering maximum airflow and visibility in milder conditions — we've got you covered. Thanks to its durable, high-grade 20D Sil-Nylon fabric, this tarp is not only fully waterproof and lightweight, but also impressively quiet, even in heavy rain. Ridgeline and extra tie-out points are already seam-sealed. No need for you to worry about it.

- Waterproof (1500 mm)
- Fits all TTTM hammocks — except Honeymoon and Mammock
- Protection from rain, sun and wind
- 16 Quick-release buckles for easy set-up
- Compact and lightweight
- Comes in a Moon Pouch + with waterproof roll-top bag for safe transportation
- Contrast-colored ridgeline with carabiners for easy setup
- Mesh pockets for storing all guy lines

LIGHTEST TARP

(TMLTPARPA)



Easily packable!

Material	20D Recycled Ripstop Sil-Nylon
	(1500 mm water column)
Min. Weight	395 g (4× guy ropes)
Max. Weight	470 g (8× guy ropes, 2× pegs)
Size	250 × 250 cm
Diagonal	350 cm
Guy rope: Blue	2 × 2.5 m
Yellow	4 × 2 m
Orange	2 × 1 m (Incl. 8 carabiners & quick-release-tension-buckles 2 ×)

Fast protection from rain, sun, and wind — while keeping weight to a minimum! Install it high for maximum shade and airflow, or low to keep rain and wind at bay. Reinforced sides, corners, and tie-out points make this minimalist piece of gear impressively sturdy. The 20D Sil-Nylon material allows the Lightest Tarp to offer full functionality. It features quick-release tension buckles on all four corners, two pegs, and four additional tie-out loops. The blue-colored ridgeline tie-outs with carabiners ensure easy orientation and fast installation. Ridgeline and extra tie-out points are already seam-sealed.

- Waterproof 1500 mm
- Fits all TTTM hammocks — except Honeymoon and Mammock
- Shields from rain, sun and wind
- 8 Quick-release buckles for easy set-up
- Compact and lightweight
- Comes in a Moon Pouch + with waterproof roll-top bag for safe transportation
- Contrast-colored ridgeline for easy setup with carabiners
- Mesh pockets for storing all guy lines

UNIVERSAL BUG NET 360°

(TMNET)



Black (TMNET07)

Green (TMNET24)

- Double zipper opens entire top
- Includes adjustable (non-structural) ridgeline
- 360° protection
- Extra fine mesh (200 holes/cm²)
- Washable at 30°C
- Mildew resistant
- Compact and lightweight

Would you like full protection and great functionality with minimal weight? This versatile 485 g bug net ensures you won't get bitten from below, thanks to its smart 360° setup. It's compatible with standard hammocks (without spreader bars) and fits all of our 3-meter-long hammock models. The soft yet durable polyester mesh keeps out even the tiniest insects, snakes, rodents, and other critters. The fully convertible top opens quickly with double circular zippers — offering extra freedom of movement or increased airflow when needed. Stuff a shirt into the soft pouch to turn it into a pillow. For stargazers, we recommend the black net.

Material	Polyester
Netting	200 mesh openings/cm ²
Weight	485 g
Size	300 × 130 cm

MOONQUILT ALLROUND



Outer material	Recycled -Crinkle Nylon 20D 44 g/m ²
Inner material	Upcycled Crinkle Nylon 70D 64 g/m ² (from hammock fabrics)
Weight	1280 g (1120 g quilt + 100 g hood + 60 g storage bag)
Size	200 × 140 cm
Filling	115 g/m ² 100% RPET Insulation ECODOWN by Thermore®
Moonquilt Temp. Range	limit comfy 3 5 20 °C

The Allround is the successor to our original Moonquilt — and its name says it all. More than just one of the best underquilts on the market, it offers impressive versatility. In windy conditions, you can zip up the recycled synthetic three-season underquilt, allowing it to fully envelop you and your hammock. Dual zippers and adjustable elastic shock cords let you easily regulate insulation from inside your hammock. Small corner pockets keep cords and mini carabiners neatly stowed when you're using it as a sleeping bag or blanket.

- Detachable hood, Machine washable at 30°C
- Mildew-resistant & water-repellent
- Can be used as underquilt or blanket (all in one solution)
- Also works as a sleeping bag (even around the hammock)
- Includes a storage bag made from upcycled mosquito netting



(TMMQA51)

MOONQUILT COMPACT



Outer material	Recycled -Crinkle Nylon 20D 44 g/m ²
Inner material	Upcycled Crinkle Nylon 70D 64 g/m ² (from hammock fabrics)
Weight	845 g (790 g quilt + 55 g bag + 60 g storage bag)
Size	210 × 135 cm
Filling	115 g/m ² 100% RPET Insulation ECODOWN by Thermore®
Moonquilt Temp. Range	limit comfy 3 5 20 °C

The Moonquilt Compact is a minimalist yet comfortable, ready-to-use three-season underquilt. Made primarily from recycled materials, it pairs perfectly with standard hammocks and our Moon-blankets.



- Machine washable at 30°C
- Mildew-resistant & water-repellent
- Can be used as underquilt or blanket (all in one solution)
- Includes a storage bag made from upcycled mosquito netting

MOONQUILT PRO 650



Outer material	20D Crinkle Nylon Downproof
Inner material	20D Crinkle Nylon Downproof
Weight	740 g (695 g quilt + 45 g bag + 60 g storage bag)
Size	210 × 135 cm (115 cm in the middle)
Filling	NHD® certified in RDS® (650 fill power; 280 g down)
Moonquilt Temp. Range	limit comfy -2 2 20 °C



- Ethically sourced, high-performance duck down
- Compatible with standard hammocks
- Lightweight and compact
- Water-resistant: retains insulation and breathability even when damp
- Exceed 10.000 minutes on the industry IDFB 18A Shake Test — equal to 7 days of continuous water exposure
- Includes a storage bag made from upcycled mosquito netting

MOONBLANKET COMPACT

(TMBCOM51)

Our Topquilt range is designed for adventure, with or without your hammock. A cosy companion to your Moonquilt and a practical addition to any outdoor setup. Built to keep you warm wherever you roam, these Topquilts are not limited to hammock life. From camping trips to travel days and everything in between, they're made to come along — even when your hammock doesn't.



Outer material	70D Crinkle Nylon (upcycled material from hammock fabrics)
Inner material	20D Crinkle Nylon 810 g (755 g blanket + 55 g bag)
Weight	
Size	205 × 135 cm
Filling	115 g/m ² 100% RPET Insulation ECODOWN by Thermore®
Moonblanket Temp. Range	limit comfy 0 5 20 °C

- Lightweight and convertible design
- Machine washable at 30°C
- Made from high-performance materials
- Compatible with standard hammocks
- Water-resistant: maintains insulation and breathability even when damp
- Includes a storage bag made from upcycled mosquito netting



MOONBLANKET PRO 650

(TMBPRO651)



Outer material	20D Crinkle Nylon Downproof
Inner material	20D Crinkle Nylon Downproof
Weight	740 g (655 g blanket + 45 g bag + 60 g storage bag)
Size	205 × 135 cm
Filling	NHD® certified in RDS® (650 fill power; 280 g down)
Moonblanket Temp. Range	limit comfy -3 2 20 °C

- Lightweight and convertible design
- 650 Fillpower duck down (Nikwax hydrophobic DWR and RDS certified)
- Made from high-performance materials
- Compatible with standard hammocks
- Water-resistant: maintains insulation and breathability even when damp
- Exceeds 10,000 minutes in the industry-standard IDFB 18A Shake Test — that's 7 days of constant water exposure
- Includes a storage bag made from upcycled mosquito netting



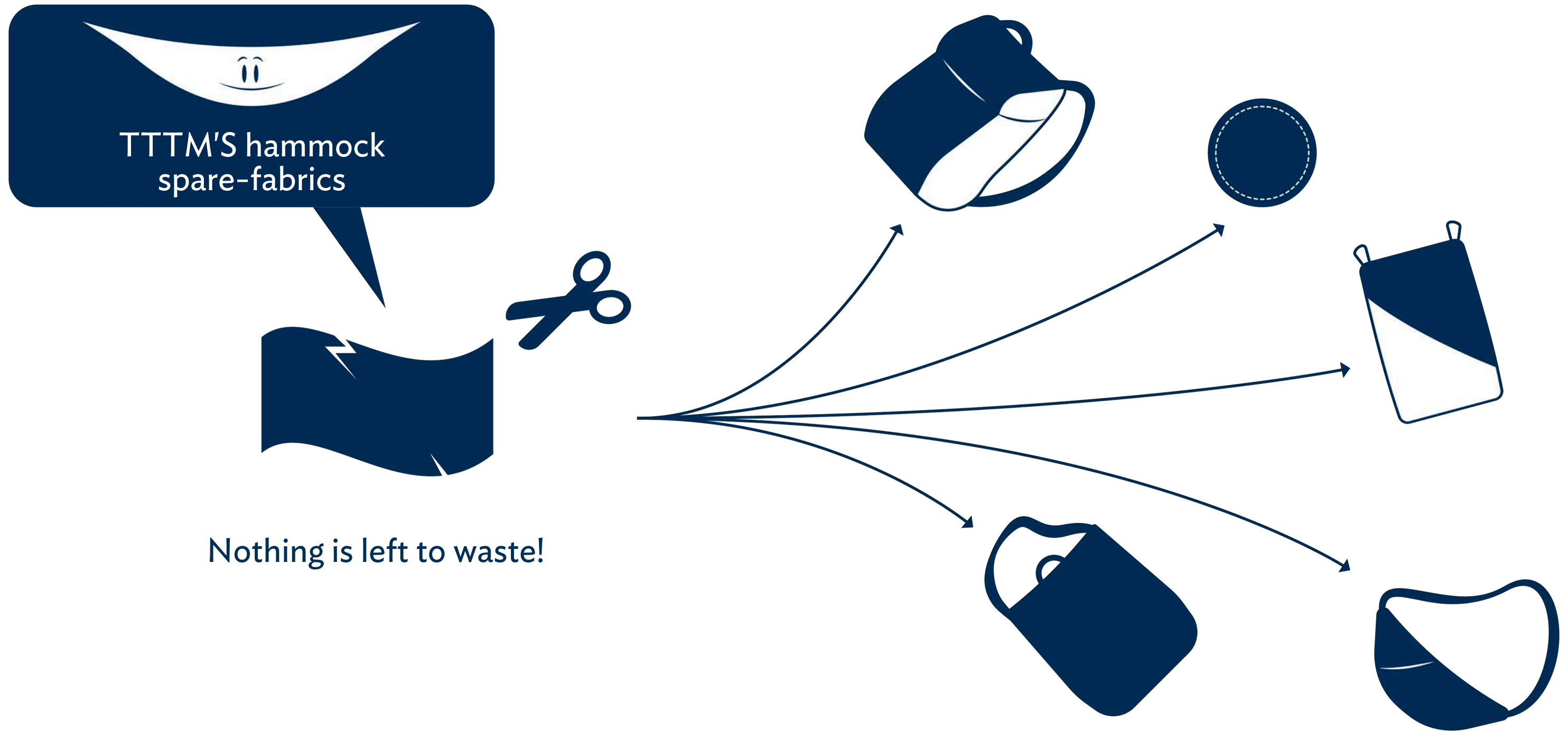

Moon Bags | Backpacks | Sling Bags | Zipper Bags | Moon Carrier

Travel Cubes & Pouch | Wash Bag | Moondisc | Moonpad

MOON BAGS

(TMMB)

MEDIUM

(TMMBM)



MEDIUM (TMMBM)

This dynamic blend of storage capacity, durability, and portability brings a new level of convenience to your everyday life. Whether you're carrying groceries or packing the essentials for a day by the lake — it's a true delight to take along.



Size 34 × 39 × 6 cm
Weight 65 g
Capacity 15 l
Carrying capacity 15 kg



Black
(TMMBM
0707)



Leaf Green
& Mint
(TMMBM
8571)



Copper
(TMMBM
8282)



Unique Edition
(TMMBMU)

LARGE

(TMMBL)



LARGE (TMMBL)

This bag can handle just about anything — even heavier items. Its spacious interior means you don't have to be selective about what you take with you. The wide handles rest comfortably on your shoulders without digging in.



Size 46 × 48 × 6 cm
Weight 80 g
Capacity 30 l
Carrying capacity 15 kg



Black
(TMMBL
0707)



Light Blue
& Cloud
(TMMBL
0977)



Mint
& Dark Grey
(TMMBL
7103)



Unique Edition
(TMMBLU)

Size
comparison



BACKPACK XS 6L



Launched in 2025, our XS backpack combines everyday ease with ultra portability. Designed for kids and adults alike, it easily carries your daily essentials or your kid's favorite cuddly toy — and disappears into your bag when not in use.

- Hidden pocket
- Eco-friendly
- Washable 30°C
- Foldable
- Top Pocket

Size 17 × 30 × 8 cm
 Weight 110 g
 Capacity 6 l
 Carrying capacity 5 kg



Black (TMBPXSo707)



Petrol Green (TMBPXs8989)



Unique (TMBPXsU)

(TMBPXs)

MINI BACKPACK 15L



A helpful companion that's ready to save the day — every day! First launched in 2012, our backpack has been refined over the years to deliver exceptional comfort and outstanding functionality.

Available in a water-resistant design!

- Laptop compartment (13")
- Eco-friendly
- Washable 30°C
- Foldable
- Top Pocket
- Super light



Size 28 × 42 × 13 cm
 Weight 140 g (Water Resistant 170 g)
 Capacity 15 l
 Carrying capacity 15 kg



Water Res. (TMMBPwRA)



Black (TMMBPo707)



Royal Blue & Aqua (TMMBP3915)



Sky Blue & Grey (TMMBP3102)



Sand & Mint (TMMBP7170)



Unique Edition (TMMBPU)

BACKPACK PLUS

(TMPBP)



Following the continued success of our original Mini Backpack — and countless user requests — we developed a larger version packed with even more features. The Backpack Plus comfortably fits 15" laptops and offers four practical compartments for flexible organization. Hidden pockets keep your valuables secure, while the chest strap keeps the shoulder straps in place, making it easier to carry your essentials.

Available in a water-resistant design!

- Laptop compartment (15")
- Hidden pocket
- 1 main pocket
- Top pocket with zippable document compartment
- 2 hidden pockets
- Eco-friendly
- Washable at 30°C
- Chest strap
- Bottle holder
- Including accessory carabiner for keys

Size 29 x 45 x 15 cm
 Weight 225 g (Water Res. 285 g)
 Capacity 25 l
 Carrying capacity 15 kg



Water Res. (TMPBPWRA) Copper (TMPBP82) Petrol Green (TMPBP89) Navy Blue (TMPBP06) Black (TMPBP07) Unique Edition (TMPBPU)



SLING BAG BASIC

(TMSLBB)



Lightweight, compact, and ready for everyday adventures: the Sling Bag Basic offers a clean design with thoughtful functionality. Two interior zippered pockets keep your essentials secure and easy to reach. The adjustable strap ensures all-day comfort — whether you're exploring the city, travelling, or just out and about.

Available in a water-resistant design!



- Can be worn under clothing
- 4 zippered pockets
- Key chain carabiner attachable in 5 different positions
- Two inner zippered keep your essentials neatly organized
- Dedicated smartphone/sunglass pocket
- Can also be worn as a hip bag
- Machine washable at 30°C



Water Resistant (TMSLBWRA)



Dark Grey (TMSLBB03)



Navy Blue (TMSLBB06)



Jade Green (TMSLBB73)

Weight 126 g (Regular) 160 g (Water Res.)
 Material 70D Crinkle Nylon
 Strap length 55 cm - 100 cm

SLING BAG MINI

(TMMSLB)



The Sling Bag family is growing! It offers just enough space to fit the favorite card game, jewelry or a unicorn toy. For larger humans who are in love with this tiny format as well, it will probably also warmly house your smartphone, cards, and keys.

- Can be worn under clothing
- 4 zippered pockets
- Key chain carabiner attachable in different positions
- Two inner zippered keep your essentials neatly organized
- Made partly from upcycled materials
- Can also be worn as a hip bag
- Machine washable at 30°C

Size	25 × 9 × 9 cm
Weight	75 g
Capacity	0.6 l



Black
(TMMSLB0707)



Plum & Light Purple
(TMMSLB7819)



Unique
(TMMSLBU)

SLING BAG GALAXY

(TMPSLB)



The other evolution that many of you have been waiting for is now ready for you! After almost two years of improving, the larger Sling Bag sibling boasts extra space, which will easily replace your handbag and even hold your water bottle and other essentials of daily life with numerous pockets for easy and fun organization. The wider straps distribute the weight comfortably on your shoulders.

- Can be worn under clothing
- 4 zippered pockets
- Key chain carabiner attachable in different positions
- Two inner zippered keep your essentials neatly organized
- Dedicated smartphone pocket
- Made partly from upcycled materials
- Can also be worn as a hip bag
- Machine washable at 30°C

Size	42 × 21 × 12 cm
Weight	195 g
Capacity	5 l
Maximum load	14 kg



Black
(TMGSLB0707)



Plum & Lavender
(TMGSLB7887)



Copper
(TMGSLB8282)

MOON CARRIER

(TMDF4oLN)

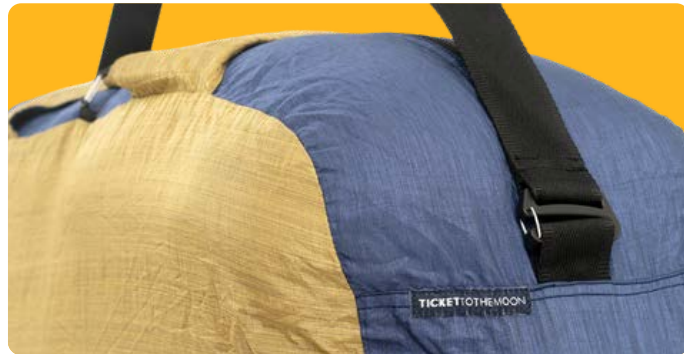

When you need more space. Perfect for transporting bulkier items like sports gear, the Moon Carrier is a true space-saver. The bottom is made from leftover tarp materials from production, making it water-resistant and ready to tackle any weather conditions.

After use, it easily folds down to a minimal size, just like all of our products. The carry straps can be conveniently secured with carabiners when travelling, keeping them out of the way. Practical, spacious, and compact — the perfect solution for those on the go.



Black
(TMDF4oLN0707)



Deep Blue & Sparkling Gold
(TMDF4oLN4823)



Easily packable
in its pouch

Size 29 × 45 × 15 cm
Weight 278g
Capacity Carrying capacity 40 l
15 kg

ZIPPER BAG

(TMEMZ)



The Zipper Bag is an evolved version of our Eco Bag, offering added security and enhanced organization.

It features a zipper, two interior pockets for better organization, and an exterior pocket for your phone. The included pouch can be used as an additional small bag and easily attached to the internal loop for extra convenience.

Lightweight yet durable, it's the perfect choice for anyone looking for a compact, organized, and stylish solution for everyday use.

Available in a water-resistant design!

Size	26 × 36 × 6 cm
Weight	80 g (Regular) 160 g (Water Res.)
Capacity	10 l
Maximum load	15 kg



The Water Res.
(TMEZWR)



Black
(TMEZO707)



Unique
(TMEZU)

TRAVEL CUBES

(TMTC)



Travel smarter with our Packing Cubes! Maximize space, stay organized, and save time. Durable and stylish, they come in three practical sizes and work best as a set. Thanks to the included carabiners, they can easily be hung wherever needed. Add a strap or rope, and they double as minimalist handbags — a true must-have for any trip!

- Eco-friendly materials
- Machine washable at 30°C
- Coconut zipper pulls
- Practical top handle for versatile use
- Includes 2 carabiners per cube
- Also available as a set in sizes S, M, L

SMALL (TMTCS)



Ultra Light Navy Blue (TMTCSL52)



Unique Edition (TMTCSU)

MEDIUM (TMTCM)



Ultra Light Navy Blue (TMTCML52)



Unique Edition (TMTCMU)

LARGE (TMTCL)



Ultra Light Navy Blue (TMTCLL52)



Unique Edition (TMTCLU)

SMALL

Size 19 × 13 × 3 cm
Weight 40 g (Regular)
20g (Ultra Light)
Carrying capacity 0.7 l

MEDIUM

Size 30 × 18 × 5 cm
Weight 50 g (Regular)
26g (Ultra Light)
Carrying capacity 2.7 l

LARGE

Size 36 × 25 × 7 cm
Weight 66 g (Regular)
33 g (Ultra Light)
Carrying capacity 6.3 l

TRAVEL POUCH

The Travel Pouch is a minimalist accessory with 2 compartments for keeping your valuables safe and secure. It comes with 2 mini carabiners to ensure everything stays right where it belongs.

Size 17 × 12 cm
Weight 27 g



Petrol Green (TMTPO3)



Dark Grey (TMTPO3)



Unique Edition (TMTPU)

(TMTTP)

TRAVEL CUBE SET

(TMTCSET)



Petrol Green (TMTCSET89)



Ultra Light-Dark Blue (TMTCSETL5252)

Venus - Unique Pastel (TMTCVSET)



Unique (TMTCSETU)

Looking for a set to be ready for any trip? This pack includes 3 bags (S, M, and L) and is a great present as well.

WASH BAG

(TMWASH)



This Wash Bag is perfectly sized for all your toiletries and hygiene essentials. It features easy full-open access with double zippers and multiple functional pockets — including waterproof, mesh, and nylon compartments — for smart, personalized organization. You'll love the detachable ultralight pouch for quick mini adventures.

- 13 pockets to organize your toiletries and first aid essentials
- Flexible, custom-designed hook fits onto almost any wall structure — or attaches easily to a carabiner
- A combination of mesh, waterproof, and leakproof pockets
- Organizer section for both classic and electric toothbrushes
- Detachable mirror
- Integrated towel holder
- Includes a detachable 50 g ultralight roll bag with 4 pockets — perfect for weekend trips
- Multiple elastic loops for small items

Size 24 × 15 × 8 cm
 Weight (reduced) 200 (150) gr
 Carrying capacity 2.8 l



Deep Blue (TMWASH48)



Moonstone Grey (TMWASH50)



Unique Edition (TMWASHU)

MOONDISC



This travel and everyday-friendly toy is entirely handcrafted from leftover parachute fabric and comes in two sizes. The Ultimate Moon Disc is similar in size to a standard ultimate frisbee, while the smaller Pocket Moon Disc is more compact and easier for kids to throw.

It flies smoothly and reliably, making it perfect for casual games — without the risk of injuries or broken gear. Plus, it folds down super small, can't break or deform, and is ideal for travel. The rim is fully filled with fabric offcuts or processed and cleaned trash from our foundation projects. Eco win!

Our latest Moon Discs, created in collaboration with “Project Wings”, bring you high-quality, durable frisbees made with the support of local communities in Sumatra. This initiative strengthens community engagement and helps expand our re.vived series—turning waste into purpose, together.

POCKET MOONDISC

(TMPDISCU)



Foldable!

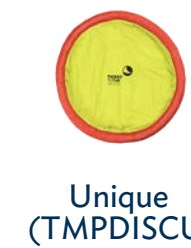

Unique (TMPDISCU)

Diameter 26 cm
 Weight 120 gr (+/-10 gr)

ULTIMATE MOONDISC

(TMUDISCU)

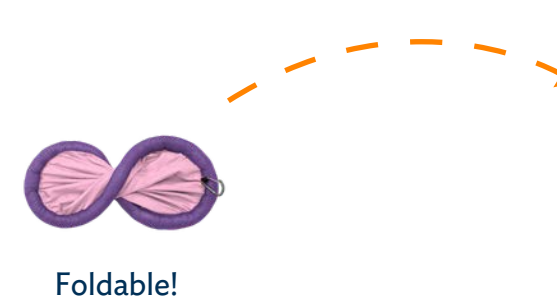

Foldable!

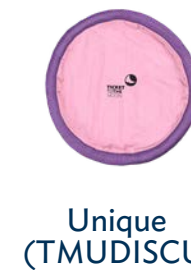

Unique (TMUDISCU)

Diameter 27.3 cm
 Weight 175 gr (+/-5 gr)

LIFESTYLE & YOGA RANGE



MOON-
CHAIR



MINI
MOON-
CHAIR



TRAVEL
BLANKET



T-SHIRT



MOONPAD



RETRACE-
ABLE KEY
CHAIN



YOGA
HAMMOCK
& BAG



TRAVEL BLANKET

(TMTB)



- High-grade parachute nylon silk
- Skin-friendly and spacious — ideal as seating or shade
- Fast-drying
- Mildew-resistant
- Compact and lightweight
- Practical corner pockets
- Packs into a compact pouch
- Has ropes in corners to anchor it to the pegs 2x 2.5 m Blue
2x 1 m Orange
(Incl. carabiners & quick-release-tension-buckles, 4x pegs)

Size 213 x 213 cm
Weight 530 g (incl. pegs)

The adjustable guy lines are stored in convenient, breathable corner pockets for safekeeping.

A versatile product that can provide cover on the floor or in the air. Offering various setup modes using the ropes and carabiners located in each of the corner, it can be attached to a tree and anchored in the ground with the pegs.



Sand & Copper
(TMTB7082)



Exotic Ocean & Petrol Green
(TMTB8889)



Easily packable in its pouch

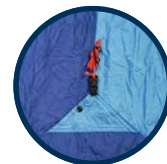

4x adjustable ropes with buckles and carabiners



4x pegs included

T-SHIRT

(TMSHIRT)



Feel good. Look good. Ticket to the Moon's T-Shirts are made from soft, breathable organic cotton — designed to keep you comfy all day long. With a relaxed fit and a casual vibe, they're perfect for everyday adventures, slow mornings, or spontaneous road trips. A bold logo on the front adds a confident statement, while a smaller logo on the back keeps things subtly cool.



L
(TMSHIRT-Po645L)

Weight 150 g



S
(TMSHIRT-Po645L)

Weight 150 g



M
(TMSHIRT-Po645M)

Weight 150 g



XL
(TMSHIRT-Po645XL)

Weight 150 g

MOONCHAIR

(TMMC)



Strong, durable, and easy to take anywhere — this comfortable chair relieves pressure from your spine and invites you to fully relax. Thanks to a smart stainless steel angle adjustment ring, you can easily find your perfect position. Crafted from our signature nylon fabric, combined with sturdy aluminium tubing and quality webbing, this foldable chair is ideal for gaming at home or for unwinding under your favorite tree after a long hike. The set includes a carrying bag, suspension rope, and a 10kN swivel carabiner for quick and easy setup — wherever you go.

- High-grade parachute nylon
- Skin-friendly and breathable
- Fast-drying
- Mildew resistant
- Adjustable seating position
- 2 practical side pockets
- Length-adjustable footrest

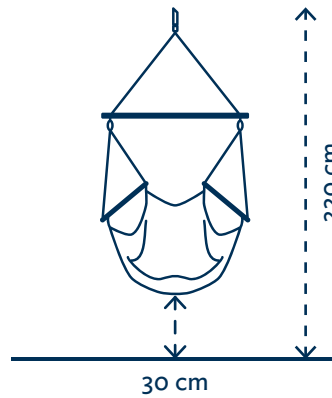

Max. load 120 kg
 Weight 1700 g
 Aluminium tubing Ø 2.4 cm

Foldable & easy to carry — in its own smart storage bag

MINI MOONCHAIR

(TMMMC)



A special, smaller Moonchair — the “portable carousel” — designed for young dreamers up to 12 years old. A wonderful gift that promises years of joy and relaxation. Comes with a carabiner and rope for easy, intuitive setup.

- High-grade parachute nylon
- Skin-friendly
- Fast-drying
- Mildew resistant
- Adjustable seating position
- 2 side pockets
- Suspension rope length 2.5 m

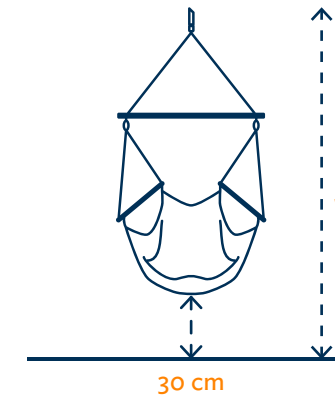

Max. load 60 kg
 Weight 1000 g
 Aluminium tubing Ø 1.9 cm

Foldable & easy to carry — in its own smart storage bag



Leaf Green (TMMC85)



Burgundy (TMMC34)



Black (TMMC07)



Mint (TMMMC71)



Peach (TMMMC76)

YOGA HAMMOCK

(TMYHP)



Some 20 years ago, we manufactured the first patented yoga hammocks together for Gravotonics, a US and Bali-based company that delivered aerial yoga swings and hammocks to some of the most popular studios around the world. Some time ago, Gravotonics joined the TTTM group. Ever since, we have been redeveloping and reinventing the traditional yoga swing. It was designed to be strong, secure, and easy to set up and ideal for aerial yoga, acrobatics, or just relaxed floating. We added premium handles and a convenient adjustment system to fit most bodies, requirements, and situations.

General benefits of aerial yoga include improving flexibility, strengthening the core, and gently decompressing the spine for better posture and overall well-being. The floating sensation supports relaxation, relieves stress, and creates the ideal setting for mindful movement and meditation.

- High-grade parachute nylon
- Skin-friendly and breathable
- Fast-drying
- Mildew resistant
- Large Swing Seat
- Adjustable height and handles
- Foam padded handles



Foldable & easy to carry — in its own smart storage bag



Deep Blue & Ice Blue (TMYHP4842)



Terracotta (TMYHP4545)

Weight 1585 g
Material 70D Crinkle Nylon
Y.H Length 300 cm
Y.H Straps 180 cm

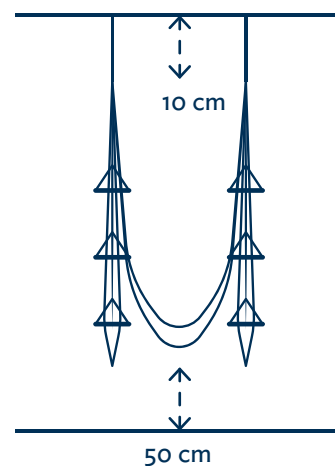

YOGA BAG BASIC IKAT

(TMYBB)



Used by the yoginis in our team for years, we felt it was time to share this product range beyond our own circle: the Basic Yoga Bag and its larger, more elaborate sibling. Both feature a stylish piece of traditional Balinese IKAT fabric, giving a beautiful hint of their origin.

Weight 230g
Material 70D Crinkle Nylon
Length 70 cm
Width 17 cm
Capacity 12 l

- 1 spacious main pocket
- 1 small pocket
- Fast-drying
- Skin-friendly and breathable
- Adjustable shoulder strap
- Lightweight
- Comfy strap for carrying



Deep Blue x IKAT (TMYBB48)



Terracotta x IKAT (TMYBB45)

YOGA BAG DUO IKAT

(TMYBD)



This is the more luxurious version for those who want to have more organising options. A large, separate water-resistant pocket will house your shoes, towel or clothing for example.

- 1 spacious main pocket
- 1 water-resistant pocket
- 1 small pocket for valuables
- Fast-drying
- Skin-friendly and breathable
- Adjustable shoulder strap
- Lightweight
- Comfy strap for carrying



Weight 375 g
Material 70D Crinkle Nylon & water-res (inside)
Length 70 cm
Width 17 cm
Capacity 12 l

MOONPAD

(TM—PADU)



Do you prefer a padded back when carrying your backpack? This foldable padding will reward you with a more comfortable feeling on your back, while it can serve you well in different ways- be it as your sitting mat when you and maybe also your friend want to be warmer, softer and dry, or when you use it as a foldable seat against your favorite tree, a pop-up rain cover, a laptop protection inside the backpack, a document pouch and so on.

- Back protector and sitting mat
- Available in 3 sizes
- Included pouch for documents
- Fast-drying
- Mildew resistant
- Fits 2 people when unfolded
- Lightweight

Plus

(TMPPADU)



Size 88,5 × 27,5 cm
Weight 110 g
Material 70D Crinkle Nylon
Compatible with Backpack Plus

Mini

(TMMPADU)



Size 84 × 26 cm
Weight 100 g
Material 70D Crinkle Nylon
Compatible with Mini Backpack

XS

(TMXSPADU)



Size 68 × 21 cm
Weight 66 g
Material 70D Crinkle Nylon
Compatible with: Backpack XS

RETRACABLE KEY CHAIN PRO

(TMZIP3)

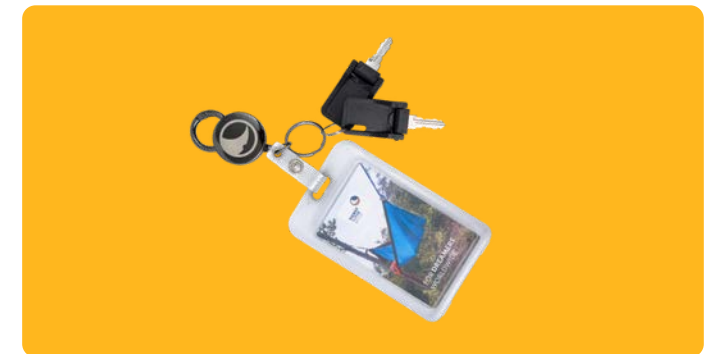

Diameter Ø 3 cm
Max. Length 68 cm
Weight 12.95 g
Material Stainless Steel

If you want to make sure you never lose your keys and equipment again, you will love this gadget! Attach it to your Sling Bag, clothing, or backpack. We decided to develop a keychain with a slightly stronger pull, so it will even return larger key bundles and parts. Easy to attach via carabiner and ready to go!



HOME HAMMOCK 320

(TMHOME320)

PREMIUM

If you're looking for a true all-rounder — perfect for both solo use and couples — you'll love our 320 Hammocks. They combine the strength and versatility of parachute silk with a soft, cotton like touch for ultimate comfort. Thanks to the compact pouch, this hammock is also easy to take along on your travels — ideal when pack size matters more than weight.



Deep Blue
(TMHOME 320-48)



Moonstone Grey
(TMHOME 320-50)



Sparkling Gold
(TMHOME 320-23)



Terracotta Orange
(TMHOME 320-45)

HOME & GARDEN LINE

Discover the Home Hammock line — your new favorite addition to home comfort and style. Designed to elevate your space, these hammocks come with upgraded features for an even better lounging experience. Crafted from stronger material, they offer enhanced durability and support without sacrificing the soft comfort you love. Available in six natural color tones, there's a perfect match for every interior — whether you're styling your living room, terrace, or cozy reading nook.

The variety in colors makes them a perfect fit for outdoor spaces, allowing you to enjoy the sunshine while lounging in style in your garden. In addition to the upgraded material and color options, each hammock in the "Home Hammock" line is equipped with rope, carabiner, and sleeves for easy setup and use. This means that you won't have to worry about purchasing any additional equipment to enjoy your new hammock. Simply unpack it, set it up, and relax in comfort.

- Premium parachute nylon
- Packed in round compact pouch
- Includes 2x 10kN carabiners
- Includes 2x 140 cm pre-knotted ropes



Including Pouch & Sleeve



Included:



Weight	1.22 kg
Carabiner to carabiner	320 cm
Width	230 cm
Max. load	200 kg
Fabric length	300 cm
Breaking strength	>580 kg

HOME HAMMOCK 520

(TMHOME520)

This is probably the most comfortable hammock in our entire range — for solo dreamers as well as for families. It might just transform the naked corner in your living room into your new favourite spot around your house, or spending time out in the garden more luring.



Deep Blue
(TMHOME 520-48)



Moonstone Grey
(TMHOME 520-50)



Sparkling Gold
(TMHOME 520-23)



Terracotta Orange
(TMHOME 520-45)

- Premium parachute nylon
- Packed in round compact pouch
- Includes 2x 22kN carabiners
- Includes 2x 140 cm pre-knotted ropes



Including Pouch & Sleeve

Included:



Carabiners



Elegant Pouch



Rope Set (2x)



Hammock Sleeve

Weight	2.26 kg
Carabiner to carabiner	520 cm
Width	300 cm
Max. load	300 kg
Fabric length	500 cm
Breaking strength	>980 kg

MOON BAGS PREMIUM

With the launch of our Home & Garden Line, it's only natural that some materials are left over — and we're putting them to good use. These offcuts allow us to give our Eco Bag range a major upgrade in comfort and color variety, all while keeping weight and pack size nearly the same.

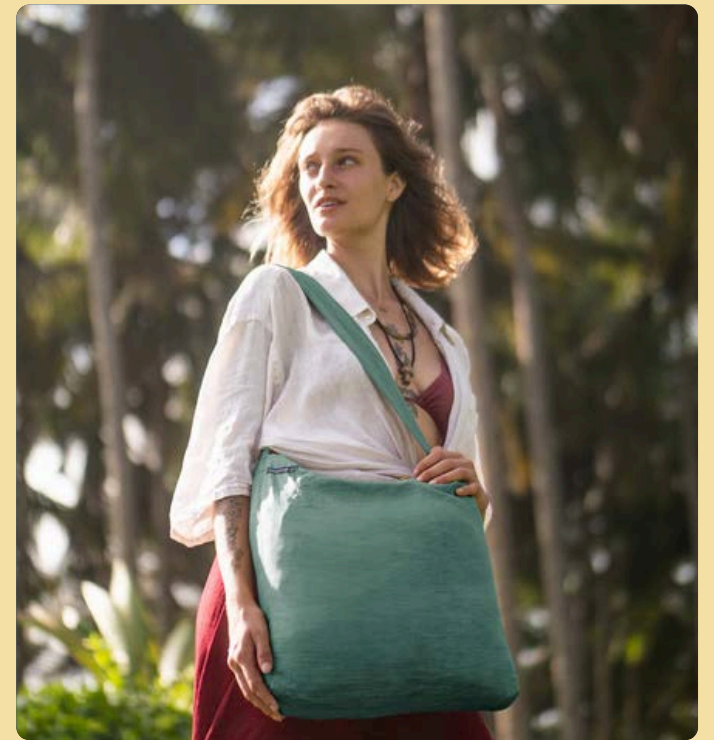

PREMIUM

MEDIUM (TMMBM-PR)

Size	34 × 39 × 6 cm
Weight	80 g
Capacity	15 l
Carrying capacity	15 kg



Sparkling Gold
(TMMBM-PR2323)



Sage Green
(TMMBM-PR4747)



Terracotta Orange
(TMMBM-PR4545)

LARGE (TMMBL-PR)

Size	46 × 48 × 6 cm
Weight	98 g
Capacity	30 l
Carrying capacity	15 kg



Sparkling Gold
(TMM-BLPR2323)



Sage Green
(TMM-BLPR4747)



Terracotta Orange
(TMM-BLPR4545)

BACKPACKS PREMIUM



Since launching our Home & Garden Hammock line, it's no surprise we've got some premium off-cuts — and of course, we're putting them to good use.

This gives our Backpack range a fresh upgrade in color and style — all while keeping weight and pack size nearly the same.

MINI BACKPACK PREMIUM

(TMMBPR)

PREMIUM

Size 28 × 42 × 13 cm
Weight 155 g
Capacity 15 l
Carrying capacity 15 kg



Ice Blue
(TMMB - PR4242)



Rossy
(TMMB - PR4646)



Sparkling Gold
(TMMB - PR2323)



Terracotta Orange
(TMMB - PR4545)

- Laptop/document compartment (13")
- Eco-friendly materials
- Machine washable at 30°C
- Foldable design
- Top Pocket

BACKPACK PLUS PREMIUM

(TMPBPPR)

Size 29 × 45 × 15 cm
Weight 280 g
Capacity 25 l
Carrying capacity 15 kg



Deep Blue
(TMPBPPR48)



Moonstone Grey
(TMPBPPR50)



Sparkling Gold
(TMPBPPR23)



Olive Brown
(TMPBPPR43)

- Laptop/document compartment (15")
- 1 main pocket
- Top pocket with zippered document compartment
- 1 hidden pocket
- Eco-friendly materials
- Machine washable at 30°C
- Chest strap for extra support
- Bottle holder
- Includes accessory carabiner for keys

POINT OF SALE



Moon Display | Moon Bag Bowl | Backpack Dispenser

Ticket to the Moon is present in **hundreds of locations worldwide** — from upscale French boutiques and extreme sports retailers to street pop-up shops, festivals, and events. Our distinctive displays capture attention and bring the brand to life. Developed with input from our community, our point-of-sale (POS) materials and display solutions provide clear visual guidance on product use while maintaining a small footprint and a handcrafted, natural finish — perfectly aligned with our sustainable, functional product range.

Get inspired by our POS highlights below — and scan the QR to browse the full **POS Catalog** →



Clockwise, starting from top left: Rack, Backpack Dispenser, Slat Wall, Mono Display, Hammock Hanger;

COMMUNITY

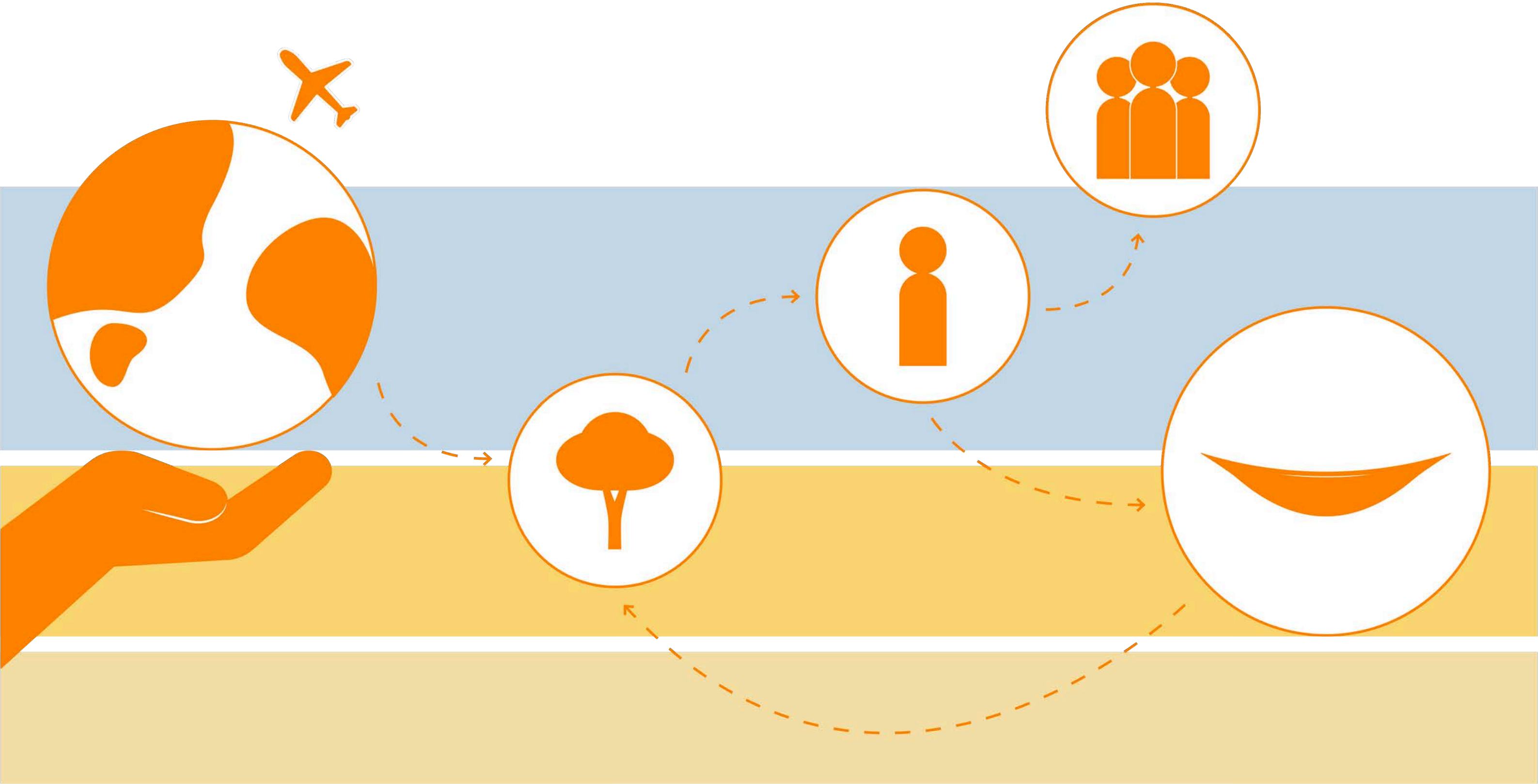



SOCIAL & ENVIRONMENTAL PROJECTS

A JOURNEY WE SHARE

Everything we do — whether it is supporting a Safe House in Sumba, installing solar panels, investing in cleaner mobility, or shifting toward recycled materials — is connected by **one belief: that business should primarily create value beyond profit.**

The people around Ticket to the Moon have always been part of this journey. Our customers, partners, and supporters are not just buying products; they are helping shape the kind of company we become. That trust means a lot to us, and it motivates us to keep growing in the right direction.

We want to continue building a company that stands for freedom, adventure, fairness, and care — for people and for the planet. The TTTM Foundation is one important way of making that vision tangible. It allows us to support vulnerable communities, respond to real needs, and deepen the positive role we can play in the world.

Thank you for being part of this story. Every hammock you hang, every product you choose, and every bit of support you give helps us weave something bigger: a world that is a little fairer, a little greener, and a little more human.

SOCIAL & ENVIRONMENTAL PROJECTS

Over the past years, we've been fortunate to witness real change. Together with our friends and partners in Sumba, we've significantly improved local living conditions. The progress has been so remarkable that the **TTM Foundation's** direct involvement is now **gradually coming to an end**. We're proud of how the project has developed and continue to support our Sumbanese friends with advice when needed — while cheering them on from the sidelines.

With this chapter closing, we're shifting our focus to **new, meaningful social and environmental initiatives** that align with our values and vision of a better world. As an organisation committed to sustainability and social responsibility, we believe in giving back and supporting those in need. We're currently in a phase of reorientation and actively seeking new projects and partners. If you know of an initiative that could benefit from our support, let us know!

In addition to various collaborations—including the donation of 200 sleeping bags to people experiencing homelessness in Austria (our second home), in partnership with Caritas — **our main partnerships** include:

SOLEMEN

One of our valued partners is the humanitarian project Solemen, a non-profit organization based in Bali, Indonesia. Solemen supports individuals living with disabilities, chronic illnesses, and life-threatening conditions, especially those who cannot afford medical care, rehabilitation, or basic necessities. They also raise awareness around key social and health issues through community campaigns and events. Ticket to the Moon deeply appreciates the impactful work Solemen is doing and proudly supports their cause. As part of our collaboration, we've donated printed eco-bags made from eco-friendly, reusable materials. These bags feature both the Solemen and Ticket to the Moon logos, helping to raise awareness for Solemen's mission while promoting sustainable habits. With this initiative, we encourage the use of reusable bags over single-use plastic. By supporting Solemen with eco-bags, we help reduce plastic waste and contribute to income opportunities — all while standing behind a cause we truly believe in.



Our team believes in giving back to society and is committed to supporting worthy causes. One way we support Solemen is by **providing Moonchairs to disadvantaged families**, especially those with disabled children. These families, once isolated in a poor area of Denpasar, now live in the Renon district, in clean, accessible housing with wheelchair access, thanks to Solemen's collaboration with the Bali government. The children benefit greatly from regular therapy, nutritious food, and emotional support. Previously, they had no opportunity to play. Now, they're **enjoying the freedom of swinging** and discovering new ways to have fun. **What a joy!**



PROJECT WINGS

Project Wings is a growing **German NGO** focused on addressing three critical global issues: species **extinction**, tropical **deforestation**, and plastic **pollution**.

They are currently building the **world's largest recycling village** in Indonesia, using 250 tons of plastic waste to create Ecobricks for affordable housing. This self-sustaining project, run by locals, combines environmental protection, nature conservation, and animal welfare.

In addition to protecting rainforests and promoting plastic alternatives, Project Wings is committed to education and advancing animal welfare.

Project Wings plans to build a sustainable marketplace, sports grounds, and an organic restaurant. Our latest **Moondiscs, created in collaboration** with Project Wings, are high-quality, durable frisbees made with the help of local communities in Sumatra. This initiative supports local engagement and furthers our commitment to upcycled production.

We will also **provide hammocks for community patrols** and sleeping cabins for the team and supporters. Currently, we're in the planning phase of the next steps to raise awareness in Sumatra.

One man's trash is another man's treasure!



SOCIAL & ENVIRONMENTAL PROJECTS



SUSTAINABILITY AS RESPONSIBILITY, NOT MARKETING

For us, **social impact and environmental responsibility go hand in hand**. Supporting people while ignoring the climate crisis would be incomplete. In the same way, talking about sustainability without measurable action would not reflect who we want to be.

At Ticket to the Moon, we believe sustainability must be grounded in honesty, accountability, and science. It cannot just be a slogan or a decorative layer of branding. It has to be built into the way a organization operates, measures itself, and improves over time.

That is why **we have integrated carbon accounting** into our operations and **aligned our climate work with the Science Based Targets initiative (SBTi)**. This means that instead of guessing about our footprint, we are working to understand it properly — across our operations, materials, transport, and broader value chain. **By measuring our emissions and identifying where our biggest impacts lie**, we can focus our efforts where they matter most.

Our ambition is clear: **we want to reduce our carbon footprint significantly by 2030**, in line with science-based climate goals. This is not a vague aspiration. It is a structured process that requires data, analysis, operational change, and continuous follow-through.

TURNING CLIMATE GOALS INTO (DAILY) ACTION

Sustainability only becomes meaningful when it changes how you work every day. For us, that means transforming our operations from the inside out — starting at home, here in Bali.

One key area is **energy**. We have been expanding the use of **solar power** at our factory, making greater use of the abundant Indonesian sun to support our manufacturing processes. Each additional panel represents more than energy savings; it represents a practical **shift toward a more resilient and lower-impact production model**.

We are also working to rethink mobility. As part of this effort, we have introduced an **electric vehicle to our fleet**. What makes this especially meaningful is that it can be charged directly through our solar-powered system. This creates a strong link between renewable energy and

daily logistics, helping us reduce emissions not only in theory, but in the everyday movement of goods and people.

Another major focus is materials. A large part of any product's footprint lies in what it is made from. That is why we are **steadily increasing the use of recycled fabrics in our collections** and continuing to explore better material solutions year by year. From moving core product lines toward recycled nylon, aluminium, and **recycled polyester** to expanding our upcycled collections, including the **Re.vived Series**, we are actively working to close loops and reduce waste.

For us, this is about progress, not perfection. We know the journey is complex, and we know there is always more to do. But we also know that real change happens through consistent steps, taken seriously over time.

Future Savings with 100% Recycled Nylon

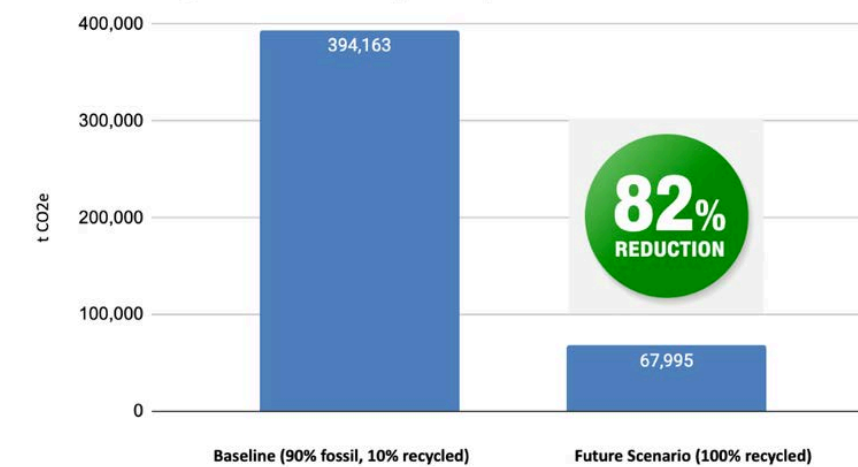

Baseline (90% fossil, 10% recycled) Future Scenario (100% recycled)

Current vs. Target Emissions by Pillar (tCO2e)

